

# HealthWise™

## Wrist Blood Pressure Monitor

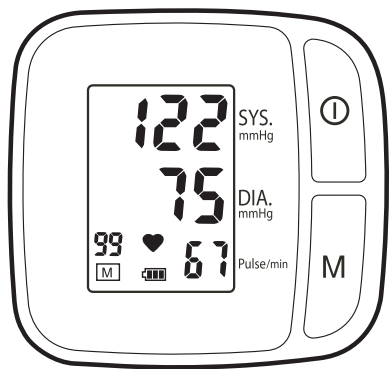

Classic Model

- Infants, young children or individuals who cannot express their consent are not suitable to take blood pressure measurement.
- Individuals with serious arteriosclerosis are not suitable to take blood pressure measurement.
- Blood pressure readings may change in case of pregnancy. Pregnant women should consult their doctor before taking measurement.
- **Self-measurement is not medical treatment. If there are unusual values, consult your doctor.**
- Handling batteries properly:
  - As soon as old batteries run out, replace with new batteries.
  - Do not use old and new batteries together.
  - Align the polarities of batteries correctly.
  - When the unit will not be used for more than 3 months, remove the batteries. Otherwise, batteries may leak and cause damage to the unit.

2

Avoid smoking, eating, drinking caffeinated drinks or exercising for 30 minutes before taking measurement

1. Sit upright in a chair with both feet on the floor.
2. Roll up the sleeve to bare your wrist if necessary. Take caution not to constrict the blood flow.
3. Pull on the end of the cuff until it wraps securely around your wrist. Place your elbow on a table so that the monitor will be at the same level as your heart.
4. Press the "⓪" button. The cuff will automatically inflate and the measurement will start.
5. When the measurement is complete, the cuff will automatically deflate and your systolic and diastolic pressure values and pulse rate will display.

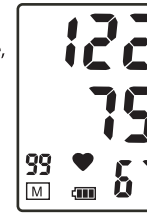

3

### Monitor

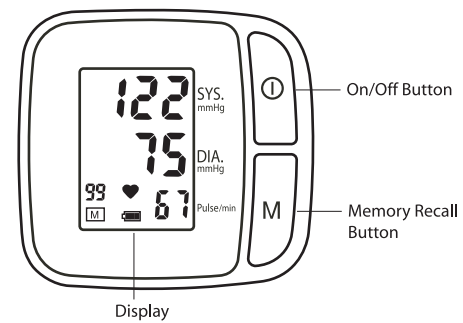

### Features

- One Touch Operation
- 99 Total Memory
- Auto-off Power Saving Feature
- Operated by 2 AAA batteries

4

### Display

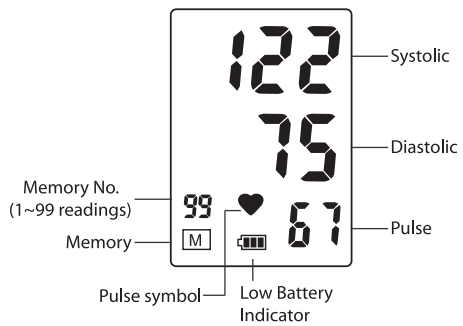

### Package Contents

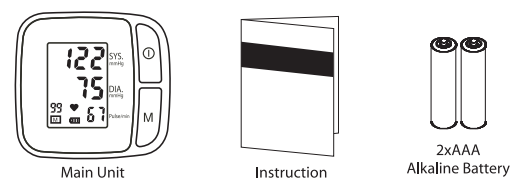

5

### PREPARATION

#### 2.1 Battery Installation

1. Remove the batteries cover according to the direction of the arrow.



2. Insert 2 AAA batteries with the polarities in the correct direction.



3. Slide the battery cover to close until the lock securely clicks into place.



**Note:** Replace batteries when the battery indicator "⓪" shows low voltage.

6

### TAKING MEASUREMENT

#### Note:

- Avoid smoking, eating, drinking caffeinated drinks or exercising for 30 minutes before taking measurement.
- Do not move or talk during measurement.

#### 3.1 Sitting Correctly

1. Relax
2. Sit upright in a chair with both feet on the floor.
3. Roll up the sleeve to bare your wrist if necessary. Take caution not to constrict the blood flow.
4. Place your arm on a table so that the cuff will be at the same level as your heart.

#### 3.2 Applying the Wrist Cuff

1. Place your elbow on a table and palm facing upward, and wrap the arm cuff around the left wrist.
2. Pull on the end of the cuff until it wraps securely around your upper wrist. Do not over tighten the cuff. Allow 1-2 cm or 1/2 inch between the bottom of the cuff and your wrist joint.
3. Make sure the cuff is at the same level as your heart.



7

### 3.3 Taking Measurement

1. Press the "⓪" button. The cuff will automatically inflate and the measurement will start.
2. When the measurement is complete, the cuff will automatically deflate and your systolic and diastolic pressure values and pulse rate will display.
3. Remove the wrist cuff and take note of your measurement results.

**Note:** You can press the "⓪" button to stop inflating the wrist cuff at any time.

### 3.4 Heartbeat Readings

Besides Systolic and Diastolic values, Pulse will also be displayed after a measurement.

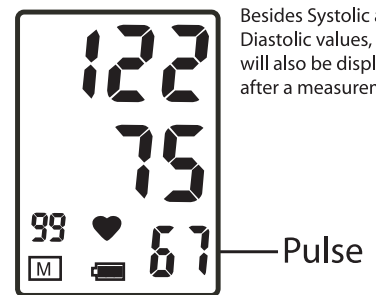

8

### Irregular Heartbeat

This unit has a unique feature that alerts the user of irregular heartbeat detection during measurement.

**Note:** An irregular heartbeat is defined as a heartbeat rhythm that has a variation of more than 25% from the average rhythm detected during measurement.

If such irregular rhythm occurs twice or more during the same measurement, the display screen will show the pulse value and "IH" symbol alternately. Example: (90 / IH)

**Note:** You may want to consult your doctor if irregular heartbeat occurs often.

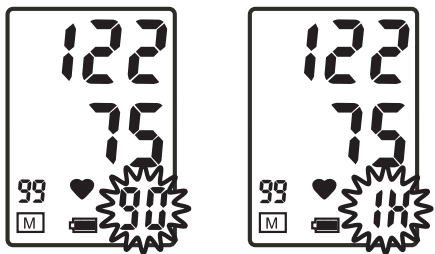

9

### MEMORY FUNCTIONS

After measurement, the last set of measured values will be saved automatically after measurement when the unit is turned off by pressing "⓪" button or by automatic power-off after 3 minutes.

#### 4.1 View Past Readings

1. Press the "M" button to enter memory function.
2. Press the "M" button to display the next set of values. Past readings are displayed from the most recent to the oldest.
3. This device can store up to 99 past readings.

#### 4.2 Delete Past Readings

User can delete all the past readings stored in memory by replacing the batteries.

10

### TROUBLESHOOTING

Problem	Cause	Solution
No display when you press the Power /Start button	Have the batteries run out?	Replace new batteries.
	Are the battery polarities wrong?	Re-align batteries in correct polarities.
"Err P" displayed	Fail to inflate	Return for servicing.
"Err 1" displayed	Deflate too rapidly	Return for servicing.
"Err 2" displayed	Movement during measurement	Do not move during measurement.
	Signal interference	Remove interfering source e.g. mobile phones, magnets.
"Err 3" displayed	Incorrect results	Measure again.

**Note:** If your problem cannot be solved by the above, please contact our customer service department for servicing. Do not disassemble the unit.

11

### STORAGE & MAINTENANCE

- Keep the unit away from direct sunlight, extreme temperatures, humidity or moisture.
- Use a dry, soft cloth to clean the unit, or if desired, use a cloth lightly dampened with water.
- Do not use alcohol, benzene, thinner or other volatile liquids to clean the unit.
- Do not wash or expose the wrist cuff to liquid.
- Remove batteries from the unit when it will not be used for more than 3 months.

12

### SPECIFICATIONS

### WARRANTY

Model No.	Classic (HW-BW101)
Measurement Method	Oscillometric
Measurement Range	Pressure: 20 - 280 mmHg Pulse Rate: 40 - 195 beats/min
Accuracy	Pressure: +/- 3 mmHg Pulse Rate: +/- 5%
Inflation	Pump driven
Pressure Detection	Semi-conductor
Power Supply	2x AAA batteries
Auto Power Off	3 minutes after last operation
Storage Environment	-4°F to 140°F, 10% to 95% RH
Operation Environment	50°F to 104°F, 30% to 85% RH
External Dimensions	3.15" (L) x 2.35" (W) x 2.96" (H) or 80 x 60 x 75 mm
Net Weight	4.59oz/130g (batteries excluded)
Cuff Dimensions	5.3-8.7in/135-220mm
Package Content	Instruction Manual, Battery Set, Main Unit

**Note:** Subject to modification without prior notice.

13

The HealthWise™ Wrist Blood Pressure Monitor is warranted to be free from defects in materials and workmanship within 5 years from the date of purchase. The monitor must be used in accordance with the instructions provided.

The above warranty is extended to only the original retail purchaser. Proof of Purchase required.

We will, at our option, repair or replace without charge the wrist monitor covered by the above warranty.

To obtain warranty service, please contact MHC Medical Products at 1 (877) 358.4342.

ALL IMPLIED WARRANTIES, INCLUDING BUT NOT LIMITED TO THE IMPLIED WARRANTIES OF MERCHANTABILITY AND FITNESS FOR PARTICULAR PURPOSE, ARE LIMITED TO THE DURATION OF THE APPLICABLE WRITTEN WARRANTY ABOVE.

14

**FOR CUSTOMER SERVICE CALL OUR TOLL FREE NUMBER:**

**1 (877) 358.4342**

**MHC Medical Products**  
100 Commerce Blvd.  
Loveland, OH 45140

Made in China to MHC Medical Products specifications.  
Package design © 2010

HealthWise™ is a trademark of MHC Medical Products.

Manufactured in accordance with  
FDA and International Standards



0123